

- 120.0 MHz IF SAW Filter / 8.95 MHz Bandwidth
- Revision 0: July 2013

Electrical Characteristics

MAXIMUM RATING				
PARAMETERS DESCRIPTION	UNIT	MINIMUM	TYPICAL	MAXIMUM
Operation Temperature Range	°C	-	+25	-
Storage Temperature Range	°C	-40	-	+85
Maximum DC Voltage	V	-	-	-
Maximum Input Power	dBm	-	-	10
Source Impedance (single ended) ⁽¹⁾	Ω	-	50	-
Load Impedance (single ended) ⁽¹⁾	Ω	-	50	-
Package type & size	D70			
Length x Width	mm ²	-	34.7 x 12.6	-
Height	mm	-	-	5.05

ELECTRICAL SPECIFICATION				
PARAMETERS DESCRIPTION	UNIT	MINIMUM	TYPICAL	MAXIMUM
Center Frequency (Fo)	MHz	-	120.0	-
Insertion Loss at Fo	dB	-	22.7	25.0
Amplitude Ripple Variation (Fo±4.00MHz)	dB _{p-p}	-	0.50	1.00
Group Delay Variation (Fo±4.00MHz)	nsec	-	40	100
Absolute Delay at Fo	µsec	-	3.80	-
Bandwidth at -1.0 dB	MHz	-	8.95	-
Bandwidth at -3.0 dB	MHz	9.00	9.20	-
Bandwidth at -40.0 dB	MHz	-	10.25	-
Bandwidth at -50.0 dB	MHz	-	10.35	10.60
Ultimate Rejection	dB	50	55	-
Temperature Coefficient	ppm/°C	-	-18	-

Notes : (1) With Matching Network (Ref. Testing Environment Circuit as shown below).
Those impedances could be modified with different impedance values and/or structures, if necessary.

Package Dimensions

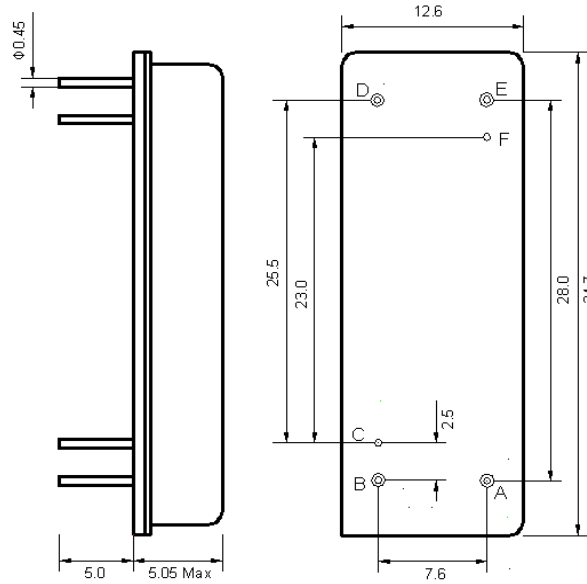

Pin Description	
B, C, D, F	Ground
A	Input
E	Output

Testing Environment

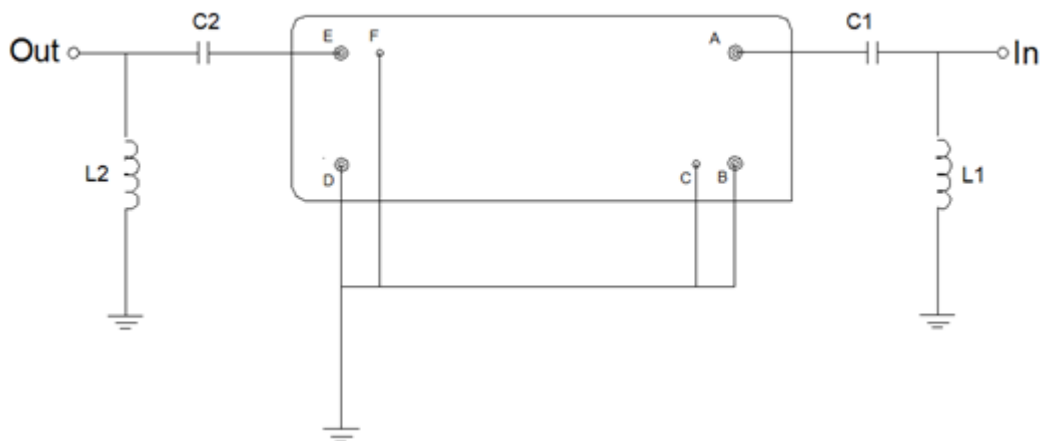

Test Fixture & Values	
Input	L1= 27 nH, C1=200 pF
Output	L2= 27 nH, C2=220 pF
Source/Load Impedance	50 Ω

Frequency Characteristics

Frequency Response

Operating Temperature: +25°C

Bandwidth at -1.0 dB

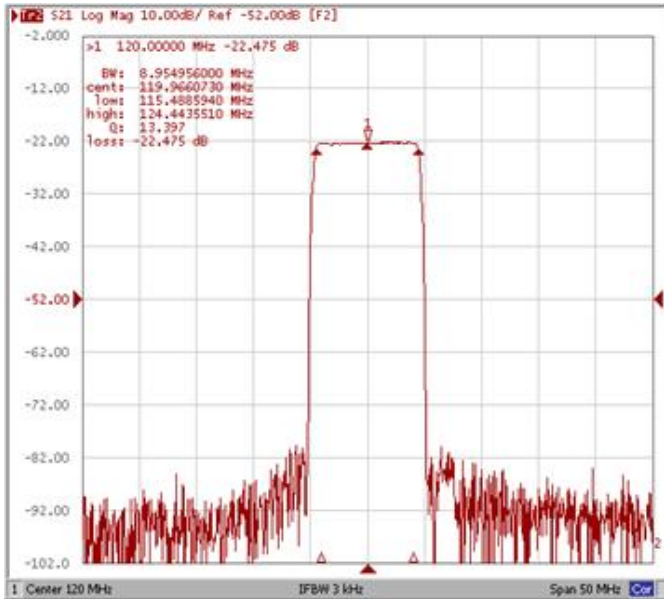

Bandwidth at -3.0 dB

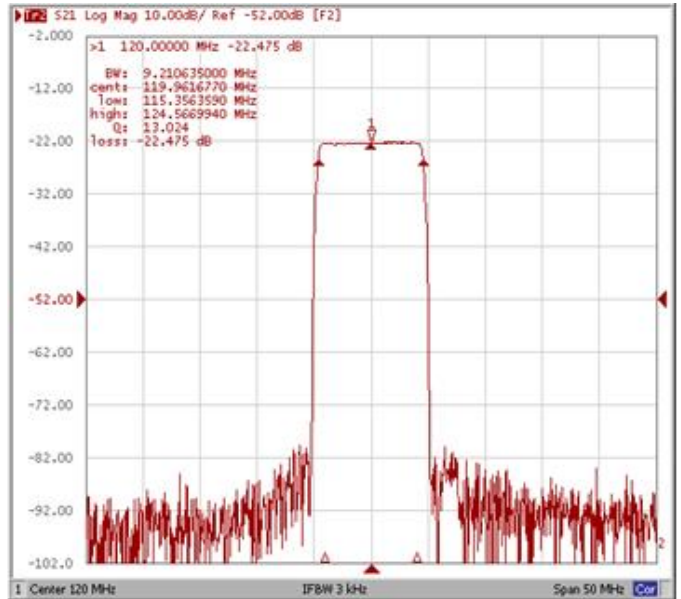

Bandwidth at -40.0 dB

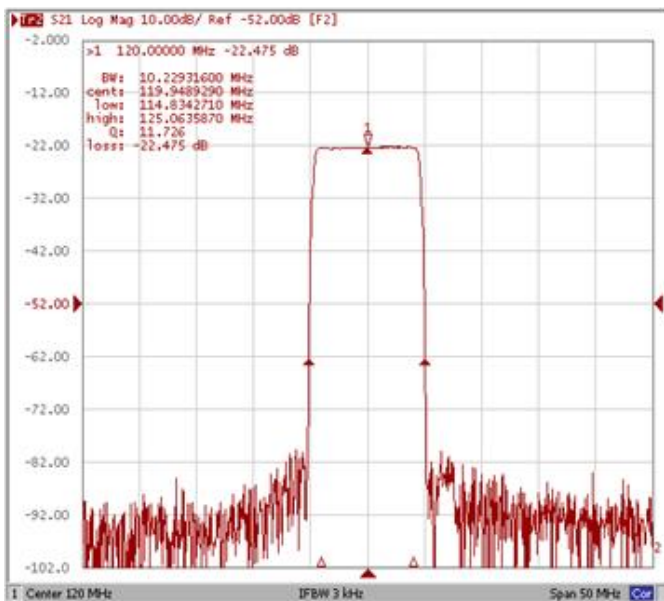

Bandwidth at -50.0 dB

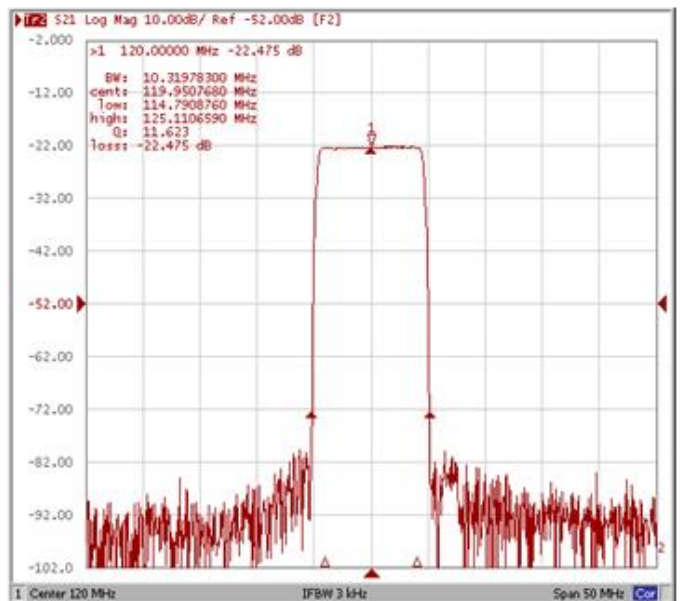

Frequency Response

Ripple Variation Fo±4.00MHz

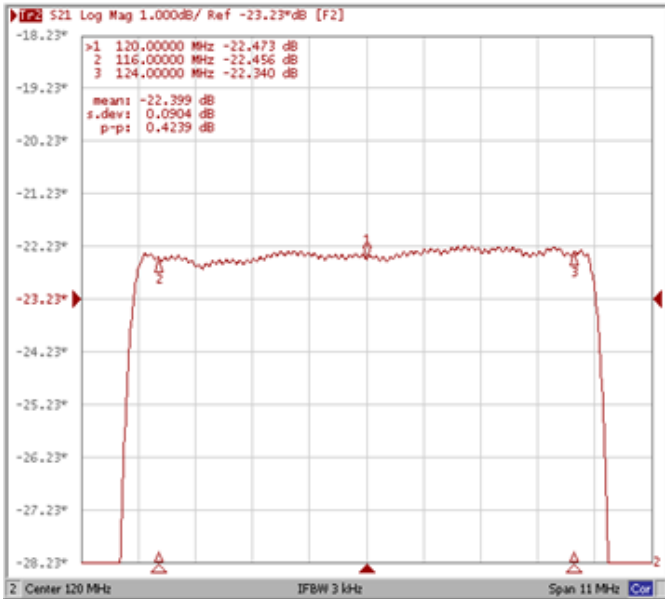

Group Delay Variation Fo±4.00MHz

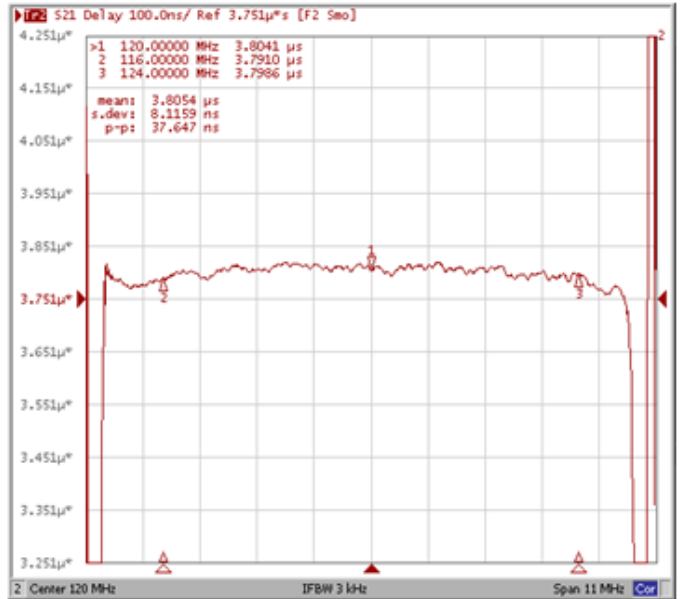

Smith Chart

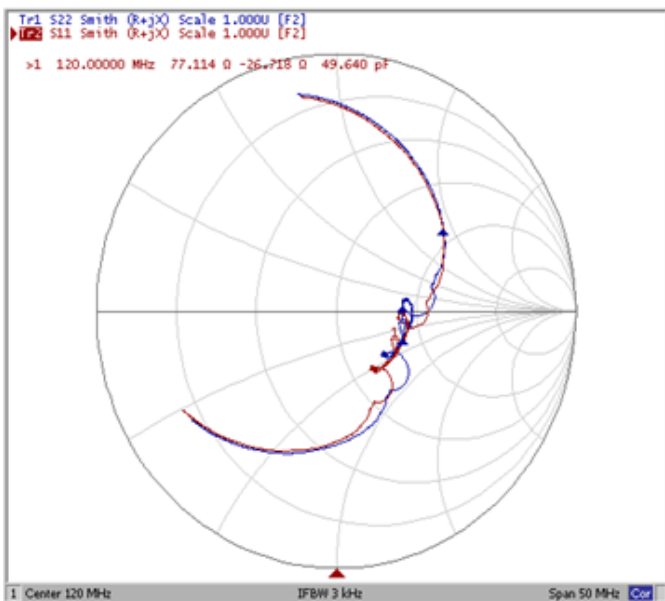

VSWR

